

Branched Spines and Contact Structures on 3-manifolds (*).

RICCARDO BENEDETTI - CARLO PETRONIO

Abstract. – We introduce and analyze the characteristic foliation induced by a contact structure on a branched surface, in particular a branched standard spine of a 3-manifold. We extend to (fairly general) singular foliations of branched surfaces the local existence and uniqueness results which hold for genuine surfaces. Moreover we show that global uniqueness holds when restricting to tight structures. We establish branched versions of the elimination lemma. We prove a smooth version of the Gillman-Rolfsen PL-embedding theorem, deducing that branched spines can be used to construct contact structures in a given homotopy class of plane fields.

The study of the *characteristic foliation* induced on an embedded surface is one of the main themes in 3-dimensional contact topology. In particular (see [10]) one can describe exactly what foliations arise («existence results»). Moreover one knows that the characteristic foliation $\mathcal{F} = \mathcal{F}_\xi(\Sigma)$ determines uniquely the contact structure ξ in a neighbourhood of a surface Σ («uniqueness results»). (By convention in this note all surfaces are closed and oriented, all 3-manifolds are oriented, all plane fields are cooriented and all contact structures are positive.) Moreover if \mathcal{F} is generic enough, so that it admits a *splitting curve* Γ (see [10]) the geometry of ξ is deeply related to the topology of the splitting; in particular Γ determines whether ξ is *tight* or not near Σ ([11], [12]). One of the basic tools in this subject is the so-called *elimination lemma* (see [10], [6]).

One could roughly summarize the contents of the previous paragraph as follows: *the study of contact structures ξ on a neighbourhood of a surface Σ can be faithfully translated into the study of the (2-dimensional) pairs $(\Sigma, \mathcal{F}_\xi(\Sigma))$* . The aim of this article is to extend this conclusion to the case of branched surfaces. (By convention in this note a branched surface P has singularities of generic type, i.e. its support is a quasi-standard polyhedron, and the branching is oriented; $S(P)$ will denote the singular set of P). We have in mind in particular the significant case where P is a *branched standard spine* of a closed 3-manifold \widehat{M} or, more specifically, P is embedded as a *flow-spine* (according to Ishii's [13] terminology) of a flow positively transversal to a given ξ

(*) Entrata in Redazione il 6 novembre 1998.

(in this case P faithfully encodes the homotopy class $[\xi]$ of ξ as a plane field on \widehat{M} and will be called a *faithful flow-spine* for ξ). The theory of branched standard spines (and in particular flow-spines) was expounded in [2], and this paper is the first development of the ideas explained there in Section 9.3. By convention, M is always a compact 3-manifold bounded by S^2 , and \widehat{M} is the corresponding closed manifold. If a spine P is embedded in \widehat{M} we always assume that the ball $B = \widehat{M} \setminus M$ is chosen so that M is a regular neighbourhood of P . If P is a flow-spine we also assume that the flow on M positively transversal to P extends to a «constant» flow on B (i.e. a traversing flow which is tangent to ∂B along a single *concave* curve, see [2] for more details).

Since a flow-spine which is faithful for ξ already carries all the information to reconstruct $(\widehat{M}, [\xi])$, our initial («uniqueness») conjecture was that the rest of the information on the geometry of ξ should be encoded by the characteristic foliation $\mathcal{F}_\xi(P)$, which can be defined in a natural way. According to Eliashberg's classification, when ξ is overtwisted its geometry is determined by $[\xi]$, so the conjecture is interesting only when ξ is tight. One of the achievements of this note is to establish the conjecture, together with a suitable «existence» result, under the restriction that the foliation is «S-stable». This means that on $S(P)$ the foliation has no singularities and the tangency points are simple, do not lie at vertices and have index $+1$ (for a natural definition of the index). Since we can show that up to C^0 -perturbation of the embedding of P the foliation $\mathcal{F}_\xi(P)$ always becomes S-stable, our result is fairly general. We also prove a weaker «local version» of this result. The two most important results of this paper are the following:

THEOREM A. – *Let P be a branched standard spine of \widehat{M} and let \mathcal{F} be an S-stable foliation on P with isolated singularities with non-zero divergence. Then there exists a contact structure ξ on \widehat{M} such that $\mathcal{F}_\xi(P) = \mathcal{F}$. Given another branched standard spine P' of \widehat{M} and a contact structure ξ' near P' such that $(P', \mathcal{F}_{\xi'}(P'))$ is abstractly diffeomorphic to (P, \mathcal{F}) , there exist neighbourhoods U and U' of P and P' respectively and a contactomorphism $\phi: (U, \xi|_U) \rightarrow (U', \xi'|_{U'})$.*

THEOREM B. – *Let (P, \mathcal{F}) be as above and suppose the contact structure carried by (P, \mathcal{F}) to be tight on a neighbourhood of P . Then there exists and is unique up to isomorphism a tight contact structure ξ on \widehat{M} such that $\mathcal{F}_\xi(P) = \mathcal{F}$. If in addition we assume that P is a flow-spine and all singularities have positive divergence then ξ can be chosen such that P is faithful for ξ , so ξ belongs to the homotopy class carried by P .*

These theorems summarize various more specific results, some of which hold under the weaker assumption that P is a branched surface, or the stronger one that a certain smooth embedding of P is fixed. We warn the reader that the isomorphism ϕ of Theorem A does not map P to P' in general, therefore one cannot conclude that the «germ» of ξ is determined by (P, \mathcal{F}) . This is why the local result is weaker than the tight global one.

In our study of $\mathcal{F}_\xi(P)$ we first establish the following facts (we provide here informal statements which will be made precise in the body of the paper):

- 1) For any branched surface P embedded in (\widehat{M}, ξ) , the germ of ξ on a neighbourhood of P is determined by $\mathcal{F}_\xi(P)$ up to isotopies which leave P invariant;
- 2) If P is a branched standard spine embedded in \widehat{M} , a *tight* structure ξ on \widehat{M} is determined by $\mathcal{F}_\xi(P)$ up to isotopies which leave P invariant;

3) Branched versions of the elimination lemma, in which the separatrix is a branched leaf, hold for any branched surface P in (\widehat{M}, ξ) ;

4) For any P in (\widehat{M}, ξ) , the embedding of P can be slightly C^0 -perturbed in such a way that $\mathcal{F}_\xi(P)$ has a certain prescribed behaviour near vertices and is S-stable; starting from a faithful P for ξ this can be achieved with P still faithful;

5) For any P in (\widehat{M}, ξ) , if $\mathcal{F}_\xi(P)$ is S-stable then any foliation C^∞ -close to $\mathcal{F}_\xi(P)$ is obtained by slightly C^∞ -perturbing the embedding of P in \widehat{M} .

Several of these results are proved by actually refining the arguments known in the case of surfaces. In particular, fact 1 relies on Moser's method and a crucial remark on the vector field generated by a branched surface according to this method. To establish fact 2 we use Eliashberg's [6] uniqueness theorem for tight structures on the ball. Facts 3 and 5 extend the proofs of Giroux [10] using *ad hoc* arguments to deal with singularities, while 4 uses the genuine (unbranched) elimination lemma.

The reader will note that the «local uniqueness» expressed by fact 1 is stronger than stated in Theorem A. This depends on a subtlety which is worth explaining soon, because it shows that the results for branched surfaces are substantially (even if not formally) different from the analogues for surfaces. The point is that, even if the branched C^∞ structure of P and the notion of C^∞ embedding in \widehat{M} are intrinsically defined, a «universal model relative to P » of a neighbourhood of P in \widehat{M} , i.e. a pair (U, P) with $P \subset U$, does not exist, while for a surface Σ one can use $(\Sigma \times \mathbb{R}, \Sigma \times \{0\})$. If one restricts to standard spines, the «absolute» diffeomorphism type of a regular neighbourhood of P in \widehat{M} is well defined, but not the way P sits in it. This implies for instance that in 1 it is not possible to interpret $\mathcal{F}_\xi(P)$ as a foliation on an abstract model of P .

Despite what just said we can prove the weak local uniqueness stated in Theorem A. Namely we show that contact structures compatible with an abstract pair (P, \mathcal{F}) , with P branched standard spine and S-stable \mathcal{F} , have isomorphic restrictions (but the isomorphism does not map P to P). A remarkable consequence of this fact is that the set of isomorphism classes of contact structures ξ on \widehat{M} such that $\mathcal{F}_\xi(P) = \mathcal{F}$ depends only on the abstract pair (P, \mathcal{F}) . Another consequence is the global uniqueness in the tight case stated in Theorem B.

Concerning constructions of contact structures our main results are:

6) If $P \subset \widehat{M}$ is a branched standard spine, \mathcal{F} is S-stable and has isolated singularities with non-zero divergence then there exists ξ on \widehat{M} with $\mathcal{F}_\xi(P) = \mathcal{F}$;

7) If $P \subset \widehat{M}$ is a flow-spine, \mathcal{F} is S-stable and has isolated singularities with positive divergence then there exists ξ on \widehat{M} such that $\mathcal{F}_\xi(P) = \mathcal{F}$ and ξ belongs to the homotopy class of plane fields carried by P ;

8) If (P, \mathcal{F}) is as in the previous point and carries a tight structure on a neighbourhood of P then there exists a tight structure ξ on \widehat{M} such that P is faithful for ξ and $\mathcal{F}_\xi(P) = \mathcal{F}$.

Concerning fact 6, note that the condition on the divergence is necessary. Note also that fact 7, combined with results from [2], contains a version via branched spines of the theorem of Lutz and Martinet according to which all homotopy classes of oriented plane fields contain contact structures. Facts 6, 7 and 8 are proved in two steps. The first step is to define the structure in a neighbourhood of P . This is the core of our ap-

proach, and the construction is quite subtle (much harder than the analogue for surfaces). It relies on fact 5 stated above and on a smooth version of the embeddability of M in $P \times \mathbb{R}$, proved by Gillman and Rolfsen in a PL setting in their work on the Zeeman conjecture [7], [8]. The second step consists in extending the structure to the ball \widehat{M}/M ; in 7 this actually requires the use of some of the techniques of Lutz-Martinet or of Eliashberg, but only on a ball, not on a general 3-manifold. In particular one can view 7 as a proof of the Lutz-Martinet theorem in which, referring to the homotopic classification of plane fields, the first (homological) obstruction is dealt with by means of branched spines, and the second one (a Hopf number) using the original approach. Fact 8 can be considered as a remarkable feature of the rigidity of tight structures.

Acknowledgement. We warmly thank Emmanuel Giroux and Paolo Lisca for many helpful and stimulating conversations.

1. – Branched standard polyhedra, embeddings and foliations.

In this section we provide a formal definition of an oriented C^∞ branched surface and we discuss the notion of embedding in a 3-manifold. Let us fix some C^∞ smooth function $h: \mathbb{R} \rightarrow \mathbb{R}$ such that $h(x) > 0$ for $x < 0$ and $h(x) = 0$ for $x \geq 0$. In \mathbb{R}^3 we consider the following surfaces, all oriented so that the projection on $\mathbb{R}^2 \times \{0\}$ is positive:

$$\begin{aligned} \Sigma_1 &= \mathbb{R}^2 \times \{0\} & \Sigma_2 &= \{(x, y, h(x)): x, y \in \mathbb{R}^2\} \\ \Sigma_3 &= \{(x, y, -h(y)): x, y \in \mathbb{R}^2\} & \Sigma_4 &= \{(x, y, -h(-y)): x, y \in \mathbb{R}^2\} \end{aligned}$$

and define $D = \Sigma_1$, $E = \Sigma_1 \cup \Sigma_2$, $V_+ = \Sigma_1 \cup \Sigma_2 \cup \Sigma_3$, $V_- = \Sigma_1 \cup \Sigma_2 \cup \Sigma_4$.

Let P be a quasi-standard polyhedron (a fully 2-dimensional finite polyhedron with singularities of stable nature). We will always assume that P has a fixed «screw-orientation» (see [3]: this means that a neighbourhood of $S(P)$ can be embedded in oriented 3-manifolds, and we know which embeddings are positive). We will endow E and V_\pm with the screw-orientation induced by \mathbb{R}^3 .

We will call *oriented branched C^∞ structure* on P a finite collection of functions $d_i: D \rightarrow P$, $e_j: E \rightarrow P$, $v_k^\pm: V_\pm \rightarrow P$ such that:

1) The union of their images covers P , each of them is a homeomorphism onto an open subset of P , and the r_j 's and v_k^\pm 's preserve the screw-orientations;

2) Let f, g be two of the maps of the family, and let A be a connected component of the domain of $f^{-1} \circ g$; let Σ be one of the Σ_i 's contained in the domain of g , and consider the restriction of $f^{-1} \circ g$ to $A \cap \Sigma$; then (for all choices of f, g, A, Σ) this map should take values in one of the Σ_i 's and should be oriented and C^∞ smooth as a map between surfaces.

When P is endowed with such a structure we call it a C^∞ *branched surface* (from now on we will always omit to specify the *orientation*). If P, \tilde{P} are branched surfaces, a map $a: P \rightarrow \tilde{P}$ is called a *diffeomorphism* if it is a homeomorphism and given any two of the functions f and \tilde{f} which define the C^∞ structures, the restriction of $\tilde{f}^{-1} \circ a \circ f$ to each of the Σ_i 's takes values in one of the Σ_i 's and is smooth and oriented. Two structures on the same P will be viewed as equivalent if the identity is a diffeomorphism. One sees in

particular that the equivalence class of a *branched C^∞ structure* does not depend on the particular function h fixed at the beginning.

Let us recall that in [2] we have introduced the notion of a (combinatorial) branching on a quasi-standard polyhedron P exactly to translate the idea that a tangent plane should be well-defined everywhere on P . We have also shown (this will be sufficient for the sequel) that in the oriented case a branching is just an orientation for each of the components of $P \setminus S(P)$ such that no edge of $S(P)$ is induced the same orientation 3 times. The following is established quite easily:

PROPOSITION 1.1. – *An oriented combinatorial branching on P allows to define on P a structure of C^∞ branched surface, unique up to diffeomorphism.*

If P is C^∞ , we will call *smooth surface contained in P* any subset locally contained in one of the Σ_i 's and open there. A function $a: P \rightarrow \mathbb{R}$ is called *smooth* if a is smooth when restricted to each smooth surface contained in P . In a similar way one defines smooth functions from \mathbb{R} to P . We will denote in the sequel by N an arbitrary (open or closed) oriented smooth 3-manifold. An *embedding* of P into N is a map $i: P \rightarrow N$ which is a homeomorphism of P into its image and is an embedding in the usual sense when restricted to each smooth surface contained in P . We will always tacitly assume that i respects the screw-orientation.

Having in mind the case of genuine surfaces, an important difference arises when one considers embeddings of branched surfaces in 3-manifolds. Namely, if $i_0, i_1: \Sigma \rightarrow N$ are embeddings of an oriented compact surface into an oriented 3-manifold, then $i_1 \circ i_0^{-1}$ extends to a diffeomorphism between tubular neighbourhoods of the images. This is false for branched surfaces, as the following lemma already shows in dimension two.

LEMMA 1.2. – *Consider the maps $f, g: \mathbb{R} \rightarrow \mathbb{R}$ given by $f(x) = g(x) = 0$ for $x \geq 0$ and $f(x) = \exp(1/x), g(x) = \exp(-1/x^2)$ for $x < 0$. Let F (resp. G) be the union of the graphs of f and $-f$ (resp. g and $-g$). Then there exists no C^1 diffeomorphism $\phi: \mathbb{R}^2 \rightarrow \mathbb{R}^2$ such that $\phi(F) = G$.*

PROOF OF 1.2. – We only give a sketch. If ϕ exists then $\phi(0) = 0$. Moreover ϕ distorts the metric in a bounded way near 0. The two branches of G approach each other incomparably faster than those of F , and this implies that $(\partial\phi/\partial x)(x, f(x)) \rightarrow +\infty$ as $x \rightarrow 0^-$. ■

Note however that if P is a standard spine then P always has a neighbourhood which is homeomorphic, and hence diffeomorphic, to the manifold with boundary $M(P)$ defined by P , but the way P sits in $M(P)$ is only determined up to homeomorphism, not diffeomorphism (in other words, $i_1 \circ i_0^{-1}$ may not extend to a diffeomorphism). One way to overcome this difficulty, which we will sometimes refer to in this paper, is to go back to the beginning of the section, choose a definite function h and require that the embedding of P into N should extend, in each of the local models D, E, V_\pm , to an embedding of \mathbb{R}^3 . This will be called an h -embedding of P in N . It is easily checked that indeed if i_0, i_1 are h -embeddings for the same h then $i_1 \circ i_0^{-1}$ extends to a diffeomorphism between neighbourhoods.

We will now introduce another notion of embedding, which builds on the results of [2] and relates branched polyhedra to contact structures. We consider a closed manifold $\widehat{M} = M \cup B$. Let us recall that certain standard spines P (called flow-spines) of M can be endowed with an oriented branching such that there exists $v \in \mathcal{X}(\widehat{M})$ with v positively transversal to P and (B, v) diffeomorphic to a constant field on B^3 . Moreover P determines the homotopy class of v , and all classes are carried by some P . Now consider a contact structure ξ on \widehat{M} . We will say that P is embedded as a *faithful flow-spine* for ξ if there exists v as above which moreover is positively transversal to ξ . Note that in this case P encodes the homotopy class of ξ .

We remark now that several differentiable notions, like tangent vectors, foliations and differential forms can be defined in an obvious way for branched surfaces. Moreover, if P is a branched surface embedded in a contact manifold (N, ξ) then the *characteristic foliation* $\mathcal{F}_\xi(P)$ induced by ξ on P is well-defined. The following two lemmas are easy.

LEMMA 1.3. – *Let P be embedded in (N, ξ) . Then up to a C^∞ small perturbation of the embedding we can assume that $\mathcal{F}_\xi(P)$ has isolated singularities away from $S(P)$ and isolated simple tangency points to $S(P)$ away from vertices. Starting from an h -embedding for some h , or from an embedding of a faithful flow-spine, or both, one can find the new embedding with the same properties.*

LEMMA 1.4. – 1. *If P is a branched surface in (N, ξ) and $\mathcal{F}_\xi(P)$ is as in the previous lemma then the singularities of $\mathcal{F}(P)$ have non-zero divergence.*

2. *If P is a faithful flow-spine for ξ on \widehat{M} and $\mathcal{F}_\xi(P)$ is as in the previous lemma then the singularities of $\mathcal{F}_\xi(P)$ have positive divergence.*

Concerning the second fact, we will always use in this note the conventions of Giroux [11] on orientations. In particular, a singularity p of $\mathcal{F}_\xi(P)$ has positive divergence if and only if the orientations of ξ and P coincide at p .

We conclude this section with a result which justifies the definition (given in the introduction) of S-stable foliation on a branched surface. We first remark that if p is a simple tangency point between $S(P)$ and an oriented foliation \mathcal{F} on P , the index of p is naturally defined, as shown in Fig. 1. Recall that \mathcal{F} on P is called S-stable if it is non-singular along $S(P)$ and has simple tangencies of index $+1$ to $S(P)$ away from $V(P)$. The following result implies in particular that the germ of such an \mathcal{F} along $S(P)$ is stable under C^∞ -perturbation, whence the name.

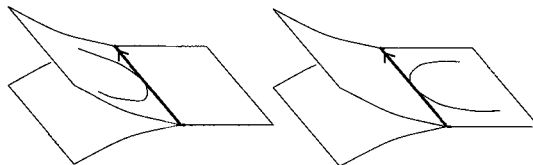

Fig. 1. – Simple tangencies of index $+1$ and -1 respectively.

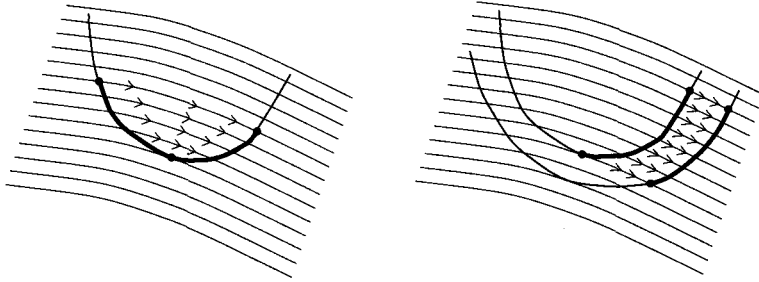

Fig. 2. - Functions defined following the leaves.

PROPOSITION 1.5. - *Let \mathcal{F} be an S -stable foliation on P . If \mathcal{F}' is sufficiently C^∞ -close to \mathcal{F} then there exists a regular neighbourhood U of $S(P)$ and a diffeomorphism $\varphi: P \rightarrow P$ such that $\varphi(U) = U$, $\varphi_*(\mathcal{F}|_U) = \mathcal{F}'|_U$ and $\varphi_*(\mathcal{F})$ is everywhere C^∞ -close to \mathcal{F}' .*

PROOF OF 1.5. - We establish some preliminary facts on planar foliations. All foliations and curves are C^∞ -smooth.

Claim 1. *Let \mathcal{F} be a non-singular foliation near $0 \in \mathbb{R}^2$ and let γ be a curve with a simple tangency to \mathcal{F} at 0 . Up to diffeomorphism we can assume that, near 0 , \mathcal{F} is horizontal and γ is the curve $t \mapsto (t, t^2)$. Of course we can assume \mathcal{F} to be horizontal. Then γ is the graph of a function $f: (-\varepsilon, \varepsilon) \rightarrow \mathbb{R}$ with $f(0) = f'(0) = 0$ and $f''(0) > 0$. So $f(x) = x^2 \cdot g(x)$ with $g(0) > 0$. Therefore $k = \sqrt{g}$ is smooth, and the required diffeomorphism is $(x, y) \mapsto (x \cdot k(x), y)$.*

Claim 2. *Let (\mathcal{F}, γ) be a pair as in claim 1, and consider the involution $g: \tilde{\gamma} \rightarrow \tilde{\gamma}$ on a closed subinterval $\tilde{\gamma}$ of γ defined as suggested on the left of Fig. 2. Then g is a diffeomorphism. This is obvious because in the universal model given by claim 1 the involution is just $t \mapsto -t$.*

Claim 3. *Let $(\mathcal{F}_i, \gamma_i)$, $i = 0, 1$, be pairs as in claim 1, and let δ_i be a curve C^∞ -close to γ_i which meets twice the leaf of \mathcal{F}_i through 0 . Consider the map $f_i: \tilde{\gamma}_i \rightarrow \tilde{\delta}_i$ between closed subintervals of γ_i and δ_i , defined as suggested on the right of Fig. 2. Then $f_1^{-1} \circ f_0$ is a diffeomorphism (whereas f_0 and f_1 are not). Claim 1 implies that we can assume that $(\mathcal{F}_0, \gamma_0) = (\mathcal{F}_1, \gamma_1)$, and the conclusion easily follows.*

Conclusion. We will denote by p_i (resp. p'_i) the tangency points of \mathcal{F} (resp. \mathcal{F}') to $S(P)$. Note that p'_i also has index $+1$ and is close to p_i . We choose a regular neighbourhood U of $S(P)$ whose boundary is very close and almost parallel to $S(P)$, except near vertices where it turns smoothly. For both \mathcal{F} and \mathcal{F}' the tangency points to ∂U have the following qualitative description: there are exactly two for each vertex of P and exactly one for each p_i (or p'_i). For each p_i we select a neighbourhood A_i which is bounded by two Y-shaped leaves of \mathcal{F} and three segments which lie in ∂U . We do the same for p'_i , taking A'_i to be almost identical to A_i , with $p_i \in A_i$ and $p'_i \in A_i$.

It is now quite easy to construct a diffeomorphism $\varphi: S(P) \setminus \bigcup_i A_i \rightarrow S(P) \setminus \bigcup_i A_i$ such that following the leaves of \mathcal{F}' and \mathcal{F} we get a diffeomorphism $\varphi: U \setminus \bigcup_i A'_i \rightarrow U \setminus \bigcup_i A_i$ which transforms \mathcal{F}' to \mathcal{F} (a little care has to be taken for the choice of φ near

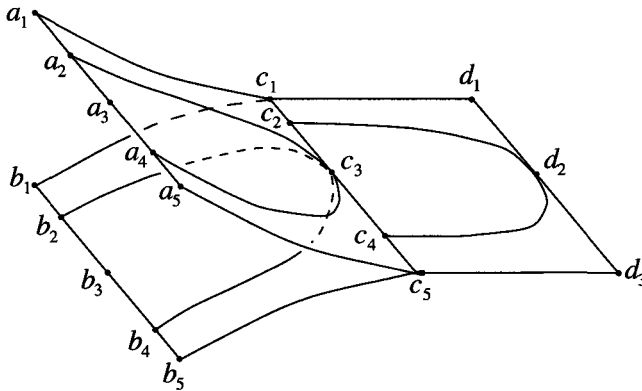

Fig. 3. - Local aspect of a singularity of index +1.

vertices). Closeness of diffeomorphisms to the identity will be easy in each step of the present proof, and will not be explicitly mentioned.

We will now extend φ mapping A'_i to A_i . To do this we note that A_i and A'_i both have a description as shown in Fig. 3. Following the leaves of \mathcal{F} we obtain various homeomorphisms between closed intervals, for instance $[a_1, a_2] \rightarrow [c_1, c_3]$, $[c_1, c_2] \rightarrow [d_1, d_2]$..., and some diffeomorphisms, for instance $[a_2, a_3] \rightarrow [a_4, a_3]$, $[c_2, c_3] \rightarrow [c_4, c_3]$ We do the same for \mathcal{F}' . Now to extend φ to a map $A'_i \rightarrow A_i$ we first extend it to $[d'_1, d'_3] \rightarrow [d_1, d_3]$ with d'_2 mapped to d_2 . Following the leaves we obtain the extension of φ to the planar quadrilaterals $(d'_1, d'_2, c'_2, c'_1) \rightarrow (d_1, d_2, c_2, c_1)$. The next step is to further extend to $[c'_2, c'_3] \rightarrow [c_2, c_3]$ and again follow the leaves to extend to $(c'_2, c'_3, c'_4, d'_2) \rightarrow (c_2, c_3, c_4, d_2)$. We proceed in a similar way to construct the diffeomorphism $A'_i \rightarrow A_i$, repeatedly using the claims 2 and 3 above to show that indeed we have a diffeomorphism and not only a homeomorphism.

The last step consists in extending φ to the whole of P . Since we do not require the foliation to be preserved, this can be done in any arbitrary way. ■

REMARK 1.6. - *The previous result does not hold if \mathcal{F} has a simple tangency p to $S(P)$ of index -1 . This is because following the leaves on the two branches on the left of $S(P)$ we construct two germs at p of involutions defined on the singular edge, and the composition of these involutions is, up to conjugation, a non-constant invariant.*

2. - Uniqueness results.

In this section we establish facts 1 and 2 from the introduction. Note that the latter implies the uniqueness part in Theorem B.

THEOREM 2.1. - *Let P be a branched surface embedded in N and let ξ_0, ξ_1 be contact structures on N such that $\mathcal{F}_{\xi_0}(P) = \mathcal{F}_{\xi_1}(P)$. Then there exist a neighbourhood U_0 of P and a smooth function $\phi: U_0 \times [0, 1] \rightarrow N$ such that:*

1. For all t the map $\phi_t = \phi(\cdot, t)$ is a diffeomorphism of U_0 onto an open neighbourhood U_t of P ; moreover $\phi_t(P) = P$ and $\phi_0 = \text{id}$;

2. $\xi_0|_{U_0} = \phi_1^*(\xi_1|_{U_1})$ and $\mathcal{F}_{(\phi_t), (\xi_0|_{U_0})}(P) = \mathcal{F}_{\xi_0}(P) = \mathcal{F}_{\xi_1}(P)$ for all t .

PROOF OF 2.1. – By simplicity of notation we will assume that the regions of P (the components of $P \setminus S(P)$) have closure homeomorphic to the closed disc. In general, when the regions are not discs or there are self-adjacencies, we would have to slightly modify the proof by cutting the regions into portions. Now we can parametrize the regions of P by maps $f_i: Q_i \rightarrow P$ where:

1) Q_i is either a closed disc or a regular n -gon for some n (for $n = 2$ we define the bigon as $\{(x, y): x^2 + (y - 1)^2 \leq 2, x^2 + (y + 1)^2 \leq 2\}$);

2) f_i is a homeomorphism onto a closed region of P and it extends to a smooth embedding \tilde{f}_i of \mathbb{R}^2 into N .

Now let us consider on N a Riemannian metric, and let us note that for all $p \in P$ the positive unit normal $\nu(p)$ to P in p is well-defined. Moreover $\nu \circ f_i$ extends to a smooth function defined on \mathbb{R}^2 . Now, up to modifying the \tilde{f}_i 's without changing the f_i 's, we can find $\varepsilon > 0$ such that the map

$$\tilde{F}_i: \mathbb{R}^2 \times (-\varepsilon, \varepsilon) \ni (x, y, t) \mapsto \tilde{f}_i(x, y) + t \cdot \nu(\tilde{f}_i(x, y))$$

is an embedding. Up to a change of scale we assume that $\varepsilon = \infty$. Let us define F_i as the restriction of \tilde{F}_i to $Q_i \times \mathbb{R}$. Even if the F_i 's are defined on subsets of \mathbb{R}^3 which are not open, we can view them as charts, because they extend to diffeomorphisms. Note that by the very construction each «coordinate change» $F_i^{-1} \circ F_j$ is the identity on the last coordinate. The condition that P is smoothly embedded implies that the images of the F_i 's cover a neighbourhood of P .

The rest of the proof follows quite closely the argument yielding the same result for surfaces, so we omit computations and confine ourselves to a description of the various steps. Let $F_i^*(\xi_j)$ be defined by a form $\alpha_j^{(i)} = \beta_j^{(i)} + u_j^{(i)} dt$. Since $F_i^*(\xi_0)$ and $F_i^*(\xi_1)$ induce the same characteristic foliation on $Q \times \{0\}$, up to multiplying one of the equations by a scalar function we can assume that $\beta_0^{(i)} = \beta_1^{(i)}$ for $t = 0$. Note that the scalar function is determined on the image of the various F_i 's, but one easily sees that it glues up to a smooth function on a neighbourhood of P .

Now we define $\xi_s = (1 - s)\xi_0 + s\xi_1$. If one considers the form $\alpha_s = F_i^*(\xi_s) = (1 - s)\alpha_0 + s\alpha_1$ and computes $\alpha_s \wedge d\alpha_s$, using the condition $\beta_0^{(i)} = \beta_1^{(i)}$ one sees that this 3-form is positive for $t = 0$, and hence for small enough t . Since there are finitely many charts F_i one deduces that $\{\xi_s\}$ is a homotopy of contact structures on some neighbourhood of P .

The next step consists in applying Moser's method. We know that a contact homotopy ξ_s yields a time-depending vector field v_s integrating which (when possible) one conjugates ξ_0 to ξ_1 . If one looks closely at the definition of v_s , one sees that if Σ is a surface and all the ξ_s 's induce on Σ the same characteristic foliation, then v_s is always parallel to the vector field which directs this characteristic foliation. In our setting, since P can be seen as a union of surfaces, this implies that v_s is always tangent to P . As

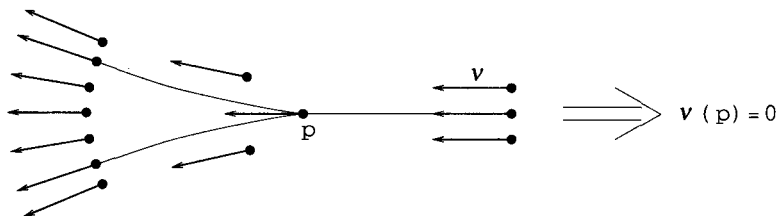

Fig. 4. - A vanishing result for vector fields.

a consequence, we deduce that *along $S(P)$ the vector field v_s is null or tangent to $S(P)$* (so in particular it is null at vertices). One can easily verify this fact directly, using some model of the embedding near $S(P)$. An indirect proof can be obtained by contradiction as suggested by Fig. 4. If v is at least C^1 then it defines a dynamical system which, as the figure shows, is non-deterministic: a contradiction.

It follows from above that the vector field v_s can be integrated up to time 1 on P and the resulting map leaves P (more precisely, all its regions) invariant. Pretty much as in the case of surfaces, this implies that v_s can be integrated up to time 1 also on some neighbourhood of P , yielding a diffeomorphism on some other neighbourhood. For a formal proof, one considers the expressions $v_s^{(i)} = w_s^{(i)} + r_s^{(i)} \cdot \partial/\partial t$, chooses constants ε, δ such that $|r_s^{(i)}(x, t)| \leq \delta \cdot t$ for $|t| \leq \varepsilon$, and shows by an a priori estimate on the solution of a Cauchy problem that starting (in some chart) with a t -coordinate less than $\varepsilon \cdot \exp(-\delta)$, time 1 is reached and (in some other chart) the t -coordinate is less than δ . This implies the conclusion. ■

PROPOSITION 2.2. - *Let P be a branched spine embedded in \widehat{M} and let ξ_0, ξ_1 be tight structures on \widehat{M} such that $\mathcal{F}_{\xi_0}(P) = \mathcal{F}_{\xi_1}(P)$. Then there exists an isotopy between ξ_0 and ξ_1 which leaves P invariant and preserves \mathcal{F} .*

PROOF OF 2.2. - Using the notations of the statement of Theorem 2.1 we can assume that U_t is a regular neighbourhood of P whose boundary S_t is an embedded 2-sphere. We can also assume that ξ_t is defined on a neighbourhood V_t of the closure of U_t , and that the foliation induced by ξ_t on S_t is the trivial one, with one source and one sink and no saddles or cycles. The last condition can be imposed to S_0 according to [11], and is then automatic for all S_t 's. Now we can extend each ξ_t to \widehat{M} by identifying the ball $\widehat{M} \setminus U_t$ with the unit ball in the standard tight structure on \mathbb{R}^3 . Eliashberg's uniqueness theorem [6] for tight structures on the ball implies that the resulting family ξ_t can be assumed to be continuous. In other words, ξ_t is a contact homotopy. The conclusion now follows using Gray's theorem (and its proof: we need to note that (P, \mathcal{F}) is invariant under the flow generated by Moser's method). ■

REMARK 2.3. - The above result holds under the a priori weaker assumption that ξ_0, ξ_1 should be tight on $\widehat{M} \setminus P$.

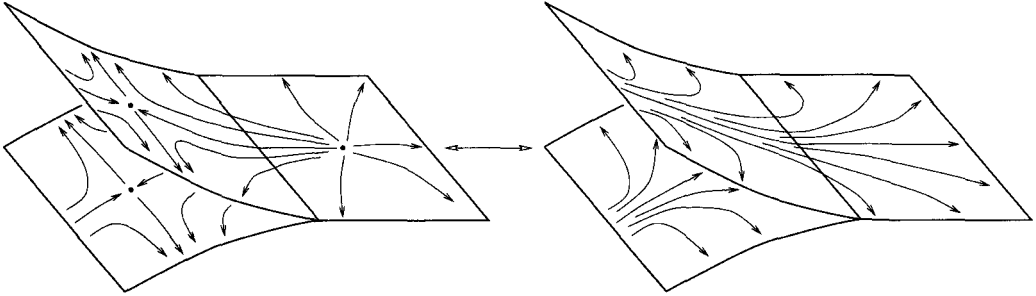

Fig. 5. - Branched elimination lemma I.

3. Modifying the characteristic foliation.

In this section we provide formal statements and proofs of facts 3, 4 and 5. We start with an easy fact which answers a natural question and will be useful later.

PROPOSITION 3.1. - *Let ξ be a plane field on \widehat{M} and let $P \subset \widehat{M}$ be a flow-spine which carries the homotopy class of the vector field positively transversal to ξ . Then P can be isotoped to be faithful for ξ .*

PROOF OF 3.1. - Let v be a vector field positively transversal to ξ . Then by [2] (or [13]) there exists a flow-spine Q for v , i.e. one which is faithful for ξ . Now by [2] Q and P are related by a sequence standard sliding moves. If we realize the sequence of moves within M we can require that v always remains positively transversal. The result is a spine P' isomorphic to P and faithful for ξ . Since the complements of P and P' are balls, P and P' are isotopic. ■

We proceed now with a branched version of the elimination lemma.

THEOREM 3.2. - *Let P be a branched surface embedded in a contact 3-manifold (N, ξ) . Then the qualitative local modifications of $\mathcal{F}_\xi(P)$ shown in Fig. 5 and Fig. 6 can be achieved by C^0 -small perturbations of the embedding, provided in both figures*

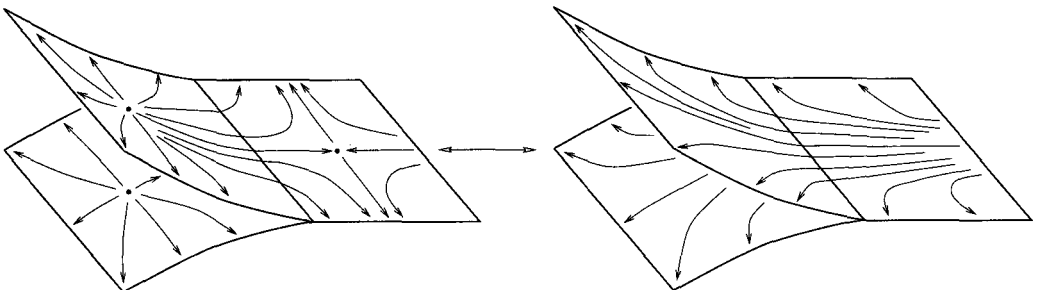

Fig. 6. - Branched elimination lemma II.

the saddle points are assumed to be positive. If we start with an h -embedding for some h (or a faithful embedding of a flow-spine for ξ , or both) then the perturbed embedding has the same properties. A similar result, except for the case of faithfully embedded flow-spines, holds for negative rather than positive singularities.

Remark. 3.3. – Just as in the case of ordinary surfaces, the statement of the elimination lemma must be understood with some care. Namely, if we denote by \mathcal{F}_0 and \mathcal{F}_1 the foliations shown in Fig. 5 (or 6) on the same abstract branched rectangle R , the result should be formally stated as follows. If P is an abstract branched surface, $\{i_0, i_1\} = \{0, 1\}$, $j_0: P \hookrightarrow N$ and $\varphi_0: R \hookrightarrow P$ satisfy $\mathcal{F}_\xi(j_0(\varphi_0(R))) = j_0(\varphi_0(\mathcal{F}_{i_0}))$, then there exist $\varphi_1: R \hookrightarrow P$ with $\varphi_1(R) = \varphi_0(R)$ and $j_1: P \hookrightarrow N$ with $j_1 = j_0$ outside $\varphi_0(R)$ and $\mathcal{F}_\xi(j_1(\varphi_1(R))) = j_1(\varphi_1(\mathcal{F}_{i_1}))$. The point we are making here is that there are various ways to fit \mathcal{F}_{i_1} instead of \mathcal{F}_{i_0} on $\varphi_0(R)$; these various ways give inequivalent global foliations on P , and we cannot prescribe a priori which one will arise. A naïve statement of the elimination lemma, in which one replaces « $\exists\varphi_1$ » by « $\forall\varphi_1$ », is easily seen to lead to contradictions already in the unbranched case. For instance one could construct an overtwisted disc around any focus, contradicting existence of tight structures.

PROOF OF 3.2. – We will assume that the reader is familiar with the details of the proof of this result for surfaces, as exposed for instance in [1]. We will first refer to the case of embeddings without further properties.

We can imagine the portion of P shown in the figures as the union of two smooth rectangles R_+ and R_- which share a square. The proof of the elimination lemma (in both directions) for each of R_\pm viewed by itself would go as follows. We first parametrize a neighbourhood of R_\pm as $\mathbb{R}_{(u, t, z)}^3$ so that R_\pm is the (u, t) -plane, the singularities and both separatrices of the saddle lie on the u -axis and the expression of ξ in coordinates (u, t, z) satisfies certain properties. Now the new R_\pm is the graph of a function $\zeta_\pm: \mathbb{R}_{(u, t)}^2 \rightarrow \mathbb{R}_z$ qualitatively described in Fig. 7, where we show cross-sections $\{u = u_0\}$ and u_0 increases from left to right.

The idea is now to find compatible parametrizations for R_+ and R_- , so that the union of the two perturbed rectangles gives a perturbed copy of P . This can be done quite easily, one only needs to be careful and take the common square to be the half-plane $t \geq 0$ in both parametrizations.

If we start with an h -embedding for some h then of course we can assume that we end up with an h -embedding: the qualitative picture of the foliation is insensitive to a C^∞ -small modification of the embedding near $S(P)$.

Let us now prove that if we start with a faithful flow-spine for ξ then we end up with a faithful flow-spine. So, let us denote by P_0 and P_1 the initial and final embeddings of P , and let us assume that there exists a vector field v_0 positively transversal to both ξ

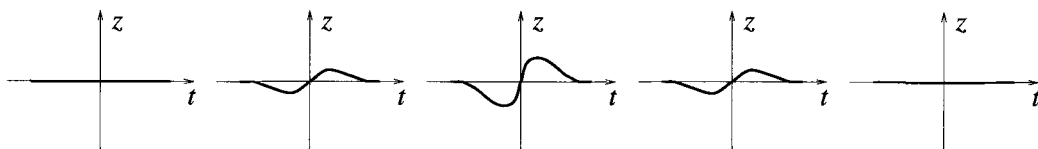

Fig. 7. – The function ζ .

and P_0 . We want to modify v_0 locally to a flow v_1 positively transversal to ξ and P_1 . We will actually do this separately for each of the rectangles $R_{\pm}^{(0)}$ and $R_{\pm}^{(1)}$ which cover P_0 and P_1 respectively: as above, the choice of compatible coordinates gives the desired result.

So, we refer to coordinates (u, t, z) as above. Let us first remark that $\partial/\partial u$ is tangent to both R_{\pm} and ξ at the points $(u, 0, 0)$. So we can get rid of the u -coordinate of v_0 , and actually assume (at least in the zone affected by the modification) that v_0 is independent of t and z . Therefore we can concentrate on one of the planes $\{u = u_0\}$ and show how to construct v_1 there. Up to rotations and dilations, since v_0 is constant, we can assume that $v_0 = \partial/\partial z$ on the plane. Now we note that $\mathcal{F}_{\xi}(\{u = u_0\})$ is non-singular, and, since v_0 is transversal to ξ , this foliation is transversal to the vertical lines parallel to the z -axis. Therefore, up to a change of chart of the form $(t, z) \mapsto (t, z - a(t, z))$, we can assume that $\mathcal{F}_{\xi}(\{u = u_0\})$ is horizontal.

Now we know that the perturbed rectangle meets $\{u = u_0\}$ in a simple curve (not a graph any more, since we have changed coordinates). Moreover, if one endows this curve and the leaves of $\mathcal{F}_{\xi}(\{u = u_0\})$ with the correct orientation, one sees from the proof of the elimination lemma and its inverse that negative tangencies never occur. Therefore the situation is as in the left-hand side of Fig. 8, and on the right-hand side of the same figure we suggest how to construct the new flow v_1 . This completes the proof. ■

We recall that, given a branched surface P , in [2] we have considered the (essentially unique) tangent vector field to P along $S(P)$ which always points to the right of $S(P)$ (i.e. it points from the locally 2-sheeted portion of P to the locally 1-sheeted portion). Following the terminology of [4] we will call *maw* this field.

PROPOSITION 3.4. – *Let P be a branched surface embedded in a contact (N, ξ) . Then:*

1. *Up to a C^0 -small perturbation of the embedding we can assume that $\mathcal{F}_{\xi}(P)$ is S -stable and directed by the *maw* at vertices;*

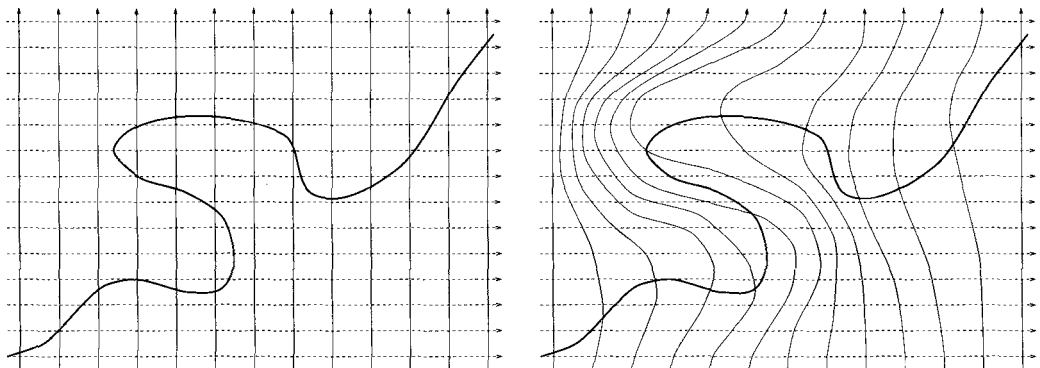

Fig. 8. – Modification of the flow.

2. If $N = \widehat{M}$ and P is a flow-spine which carries the homotopy class of the field transversal to ξ then up to isotopy (possibly not C^0 -small) we can assume that P is a faithful flow-spine for ξ and $\mathcal{F}_\xi(P)$ has the same properties as in 1;

3) In both 1 and 2, if we start with an h -embedding we can get an h -embedding.

PROOF OF 3.4. – To begin we note that in case 2 we can apply Proposition 3.1 (which involves a possibly non-small isotopy) and assume that P is faithful for ξ . We will give now a unified proof of all the statements, leaving to the reader the (easy) discussion on h -embeddings. This is because the transformations we will describe automatically preserve faithfulness.

First we modify the tangent plane to P at vertices until $\mathcal{F}_\xi(P)$ is directed by the maw there. Next, we take a small generic perturbation so that $\mathcal{F}_\xi(P)$ has finitely many simple tangency points to $S(P)$. To conclude we remove tangencies of index -1 by first creating two positive singularities (in a non-branched context) and then modifying the spine. A top view of what is happening is shown in Fig. 9; here one should imagine the portion which lies to the left of the thick line to consist of two rectangles with foliations which are vertically aligned. The modification of the spine is best understood as follows: imagine the single rectangle (on the right) to be obtained by glueing an upper and a lower rectangle, and insert your finger from the left to partially separate them. Note that Fig. 9 refers to one of the two possible orientations for index -1 , but the opposite orientation is dealt with in a similar way. ■

PROPOSITION 3.5. – Let P be a branched surface with a C^∞ -embedding i_0 in a contact manifold (N, ξ) . Assume that $\mathcal{F}_0 = i_0^*(\mathcal{F}_\xi(i_0(P)))$ is S -stable. Then any foliation \mathcal{F}_1 on P sufficiently C^∞ close to \mathcal{F}_0 is induced by an embedding i_1 of P in N which is C^∞ -close to i_0 . If i_0 is an h -embedding for some h (or a faithful embedding of a flow-spine for ξ , or both) then the same holds for i_1 .

PROOF OF 3.5. – Using stability near $S(P)$, as expressed in Proposition 1.5, we can assume that \mathcal{F}_1 coincides with \mathcal{F}_0 near $S(P)$.

Let us identify for a moment P with $i_0(P)$. Our first step will be to find a contact structure ξ' near P which coincides with ξ near $S(P)$, is arbitrarily C^∞ -close to ξ and in-

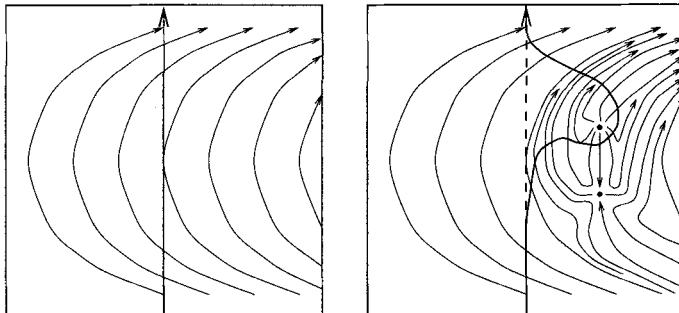

Fig. 9. – How to remove a tangency of index -1 .

duces \mathcal{F}_1 as characteristic foliation on P . We only need to describe the extension of ξ across the discs of P , so the situation is as follows. We have a disc D embedded in a 3-manifold, a contact structure ξ near D , a foliation \mathcal{F}_1 which is C^∞ close to $\mathcal{F}_\xi(D)$ on D and coincides with $\mathcal{F}_\xi(D)$ on a neighbourhood A (in D) of ∂D . We can trivialize a neighbourhood of D in N as $D \times \mathbb{R}$. Now ξ can be viewed as a 1-form, and $\mathcal{F}_\xi(D)$ is defined by the pull-back α of ξ with respect to the inclusion of D in N . Therefore the foliation \mathcal{F}_1 is defined by a 1-form $\alpha + \omega$ on D , where by assumption ω is C^∞ small and vanishes on A . Using the coordinates $D \times \mathbb{R}$ we can view ω as a form defined on the neighbourhood of D (i.e. ω is horizontal and vertically invariant). Now we can define ξ' as $\xi + \omega$. Of course ξ' induces \mathcal{F} and is C^∞ close to ξ , therefore it is a contact structure. Moreover it coincides with ξ near ∂D because ω vanishes on $A \times \mathbb{R}$.

Having found ξ' , we define $\xi_s = (1 - s)\xi + s\xi'$. Since ξ' is close to ξ , this is a contact homotopy. Moreover if we apply Moser's method the resulting time-depending vector field is constant near $S(P)$, and can be integrated up to time 1 near P yielding a diffeomorphism f defined on a neighbourhood of P , such that f is C^∞ close to the identity, f is the identity near $S(P)$ and $f_*(\xi) = \xi'$. Now it is sufficient to define $i_1 = f^{-1} \circ i_0$ to conclude. We leave to the reader the easy verification that if i_0 is an h -embedding or a faithful flow-spine then so is i_1 . ■

4. – More uniqueness results.

In this section we prove the uniqueness parts of Theorems A and B from the introduction. The reason for not including them in Section 2 is that their proof uses the technique introduced to establish Proposition 3.5.

THEOREM 4.1. – *Let P be an abstract branched standard spine of M , let \mathcal{F} be an S -stable foliation on P and let $i_j: P \rightarrow M$, $j = 0, 1$, be C^∞ embeddings. Then:*

(i) *If ξ_0 is a contact structure on M which induces $(i_0)_*(\mathcal{F})$ on $i_0(P)$ then there exists a diffeomorphism $\phi: M \rightarrow M$ such that $\phi_*(\xi_0)$ induces $(i_1)_*(\mathcal{F})$ on $i_1(P)$;*

(ii) *If ξ_0 and ξ_1 are contact structures on M which induce $(i_0)_*(\mathcal{F})$ and $(i_1)_*(\mathcal{F})$ on $i_0(P)$ and $i_1(P)$ respectively, then there exist neighbourhoods U_0 and U_1 of $i_0(P)$ and $i_1(P)$ respectively and a contactomorphism $\phi: (U_0, \xi_0|_{U_0}) \rightarrow (U_1, \xi_1|_{U_1})$;*

(iii) *If ξ_0, ξ_1 are as in (ii) and there exists a neighbourhood of $i_0(P)$ on which ξ_0 is tight, then there exists a neighbourhood of $i_1(P)$ on which ξ_1 is tight;*

(iv) *If $[\xi]$ denotes the isomorphism class of a contact structure ξ on $\widehat{M} = M \cup B$ then for $j = 0, 1$ the following sets coincide: $\{[\xi]: \mathcal{F}_\xi(i_j(P)) = (i_j)_*(\mathcal{F})\}$.*

It is perhaps useful, before the proof, to rephrase this result in less formal terms: (i) means that the property for a foliation \mathcal{F} on P of being induced by a contact structure does not depend on the embedding of P ; (ii) is a uniqueness result which however, as already pointed out in the introduction, cannot be interpreted in terms of germs; (iii) shows that, even if the germ is not uniquely defined, the property of it being tight is independent of the embedding of P ; (iv) means that the collection of contact structures on \widehat{M} which induce \mathcal{F} on P is again independent of the embedding. Note that the diffeo-

morphism ϕ which appears in (i) and (ii), and tacitly in (iv), does not map $i_0(P)$ to $i_1(P)$ in general.

PROOF OF 4.1. – We start with (i). We first choose a diffeomorphism $f: M \rightarrow M$ such that $f \circ i_1$ is arbitrarily C^∞ -close to i_0 (for the existence of f it is essential that P be a standard spine). Therefore $\mathcal{F} = i_0^*(\mathcal{F}_{\xi_0}(i_0(P)))$ and $\mathcal{F}' = (f \circ i_1)^*(\mathcal{F}_{\xi_0}((f \circ i_1)(P)))$ are arbitrarily C^∞ -close together. Since \mathcal{F} is S-stable, there exists a diffeomorphism $a: P \rightarrow P$ arbitrarily C^∞ -close to the identity such that $a_*(\mathcal{F}')$ and \mathcal{F} coincide on a neighbourhood of $S(P)$. Now one easily sees that the map

$$f \circ i_1 \circ a \circ i_1^{-1} \circ f^{-1}: f(i_1(P)) \rightarrow f(i_1(P))$$

extends to a diffeomorphism $h: M \rightarrow M$. By our choices we will have that the foliations $(h \circ f \circ i_1)_*(\mathcal{F})$ and $\mathcal{F}_{\xi_0}(f(i_1(P)))$ on $f(i_1(P)) = h(f(i_1(P)))$ are C^∞ -close and coincide on a neighbourhood of the singular set. It follows, using the technique of Proposition 3.5, that we can modify the embedding $h \circ f \circ i_1$ away from $S(P)$ to an embedding $k: P \rightarrow M$ such that $\mathcal{F}_{\xi_0}(k(P)) = k_*(\mathcal{F})$. Now, since the modification is C^∞ -small and takes place away from the singular set, it easily follows that there exists a diffeomorphism $l: M \rightarrow M$ such that $k = l \circ h \circ f \circ i_1$. The conclusion of (i) now follows by taking $\phi = (l \circ h \circ f)^{-1}$.

To prove (ii) we only need to apply (i) and Theorem 2.1 to the branched surface $i_1(P) \subset M$ and the contact structures $\phi_*(\xi_0)$ and ξ_1 .

Fact (iii) is now easy: if $(W, \xi_0|_W)$ is tight then, up to restricting W , we can assume that W is diffeomorphic to M , and apply (ii).

To prove (iv) we must show that given ξ_0 on \widehat{M} which induces $(i_0)_*(\mathcal{F})$ on $i_0(\mathcal{F})$ there exists an isomorphic ξ_1 which induces $(i_1)_*(\mathcal{F})$ on $i_1(\mathcal{F})$. To do this it is sufficient to extend the map ϕ coming from (i) to a diffeomorphism of \widehat{M} , which can be done because P is a standard spine, and define $\xi_1 = \phi_*(\xi_0)$. ■

REMARK 4.2. – To be completely formal in the above proof one should have given a priori estimates on how close the foliations must be to be able to apply the methods of Proposition 3.5 within ξ_0 . Since one can restrict from the beginning to a compact neighbourhood of $i_0(P)$ and prescribe a priori how close the various embeddings must be, this is a technical point which can be safely left to the reader.

For Theorem B the following criterion is useful:

PROPOSITION 4.3. – *Let B be an open ball in a contact manifold (\widehat{M}, ξ) . Then ξ is tight if and only if its restrictions to B and to a neighbourhood of $M \setminus B$ are tight.*

PROOF OF 4.3. – The «only if» part is obvious. For the «if» part we first recall a general definition and fact. Given (\widehat{M}, ξ) and $V \in \mathcal{X}(\widehat{M})$, we say that V is a contact field if the flow it generates leaves ξ invariant. Of course this definition makes sense also for partially defined vector fields. Now it is a general fact [10] that if α is a global equation of ξ and X is the Reeb field for α then for every $f \in C^\infty(\widehat{M}, \mathbb{R})$ there exists a unique $Y \in \mathcal{X}(\widehat{M})$ tangent to ξ such that $f \cdot X + Y$ is a contact field. This implies quite easily that partially defined contact fields always extend to global ones.

Now assume ξ is tight on B and on its complement. Up to a small perturbation, we can assume that ξ is tight near \bar{B} and that $\mathcal{F}_\xi(\partial B)$ is the trivial foliation with one source, one sink, no saddles and no cycles. Therefore, using [6], we can identify \bar{B} with the unit ball in the standard contact structure $\xi_0 = dz - ydx + xdy$ on \mathbb{R}^3 . Now one easily checks that $x \cdot \partial/\partial x + y \cdot \partial/\partial y + 2z \cdot \partial/\partial z$ is a contact field for ξ_0 , therefore it extends to a contact field V for ξ . If by contradiction ξ is overtwisted on \bar{M} then there exists an overtwisted disc D which avoids $0 \in B$. If V generates $\{\phi_t\}$ then each ϕ_t is a contactomorphism of ξ , so $\mathcal{F}_\xi(\phi_t(D))$ is «constant». Moreover for t big enough $\phi_t(D)$ is contained in the complement of B , whence the contradiction. ■

COROLLARY 4.4. – *The property of carrying a tight contact structure on a neighbourhood is a well-defined property of an abstract pair (P, \mathcal{F}) with S -stable \mathcal{F} , and it is equivalent to carrying a global tight structure on \bar{M} . Moreover, by Proposition 2.2, such a structure on \bar{M} is unique.*

5. – A smooth embedding theorem and constructions of contact structures.

In this section we show that if P is a branched standard spine of a 3-manifold M with boundary, then M can be embedded in $P \times \mathbb{R}$ in a smooth fashion. We deduce from this that the various contactization techniques known for neighbourhoods of surfaces also work for branched spines, and we apply these techniques to get contact structures which induce assigned characteristic foliations on a branched standard spine (facts 6, 7 and 8 from the introduction). By simplicity we use the same notations as before, but the results on the manifold with boundary M hold with any boundary, not necessarily S^2 .

PROPOSITION 5.1. – *Let P be an embedded branched standard spine of a manifold M with boundary. Then there exists a C^∞ embedding $i: M \rightarrow P \times \mathbb{R}$ such that $i(P)$ is arbitrarily C^∞ close to $P \times \{0\}$.*

PROOF OF 5.1. – As announced in the introduction, this result is a generalization of a theorem of Gillman and Rolfsen [7], [8] and a formal proof could be given (with considerable effort) by modifying their explicit formulae to get smooth functions. We prefer to describe the embedding pictorially: the reader will be easily convinced that a formalization is indeed possible.

We start from a 2-dimensional situation, where a branched standard spine is a train-track. In this case Fig. 10 suggests how to proceed. On the left one sees a portion of surface and the train-track embedded in it, and on the right the same portion of surface is shown as a smooth subset of the product of the train-track with \mathbb{R} . In the center we describe the same embedding avoiding 3-dimensional pictures, and also showing the position of the train-track.

Now we go back to the 3-dimensional case. The subset of $P \times \mathbb{R}$ diffeomorphic to M will contain $\{x\} \times [-1, 1]$ for all $x \in P$ except near $S(P)$. Along singular edges, but far from vertices, we only need to multiply the 2-dimensional picture by \mathbb{R} . The construction must be slightly modified near vertices, as shown in Fig. 11.

The reader should note that in the 2-dimensional case the shaded regions of Fig. 10 corresponding to D_+ and D_- could be harmlessly interchanged at some vertices. This

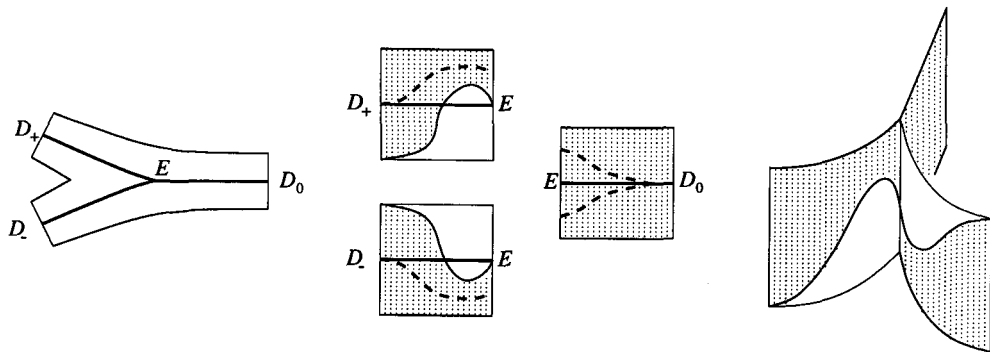

Fig. 10. - Smooth embedding in two dimensions.

cannot be done in the 3-dimensional case, because one has to make a coherent choice along edges and across vertices. Note also that to distinguish D_+ from D_- we use the screw-orientation of P (i.e. the fact that it is a spine of an oriented manifold). ■

PROPOSITION 5.2. - *Let P be a branched standard spine embedded in M , and let \mathcal{F} be an S -stable foliation on P which has isolated singularities with non-zero divergence. Then there exists a contact structure ξ on M such that $\mathcal{F}_\xi(P) = \mathcal{F}$.*

PROOF OF 5.2. - Our first step is to construct a contact structure ξ on $P \times \mathbb{R}$ which induces the foliation \mathcal{F} on $P \times \{0\}$. Note that $P \times \mathbb{R}$ is covered by finitely many charts diffeomorphic to \mathbb{R}^3 with smooth transition functions (but the charts are not open), so it makes sense to speak of contact structures. The definition of ξ is exactly the same as in the case of surfaces [11]. We take a form α which defines \mathcal{F} on P , we introduce on P an area form ω and we consider the divergence g of α with respect to ω , characterized by the relation $d\alpha = g \cdot \omega$. Then we choose another form η on P with the same singularities as α and such that $\alpha \wedge \eta$ is a positive multiple of ω except at singularities. Then, if t is the coordinate on \mathbb{R} , we just define ξ as $\alpha + t(dg - \eta) + gdt$.

The second step (i.e. the conclusion) consists once again in applying the techniques of Proposition 3.5. If we restrict ξ from $P \times \mathbb{R}$ to M we have a contact structure which induces on a branched standard spine P' arbitrarily C^∞ close to P the desired characteristic foliation. The same method used in the proof of Theorem 4.1 allows to slightly isotope ξ getting a new contact structure which induces on P exactly the desired foliation. Also in this case a complete formalization would require a priori estimates on closeness which we leave to the reader. ■

Now we are faced with the problem of extending the structure ξ from M to the complementary ball $B = \bar{M} \setminus M$. Since ξ extends as a plane field, this can be deduced directly from the techniques of Eliashberg. Alternatively, one can slightly enlarge B so that ξ is defined on a neighbourhood of ∂B , perturb ∂B until $\mathcal{F}_\xi(\partial B)$ becomes a Morse-Smale foliation and use the following remark (inspired by [5]) to be found in [9]:

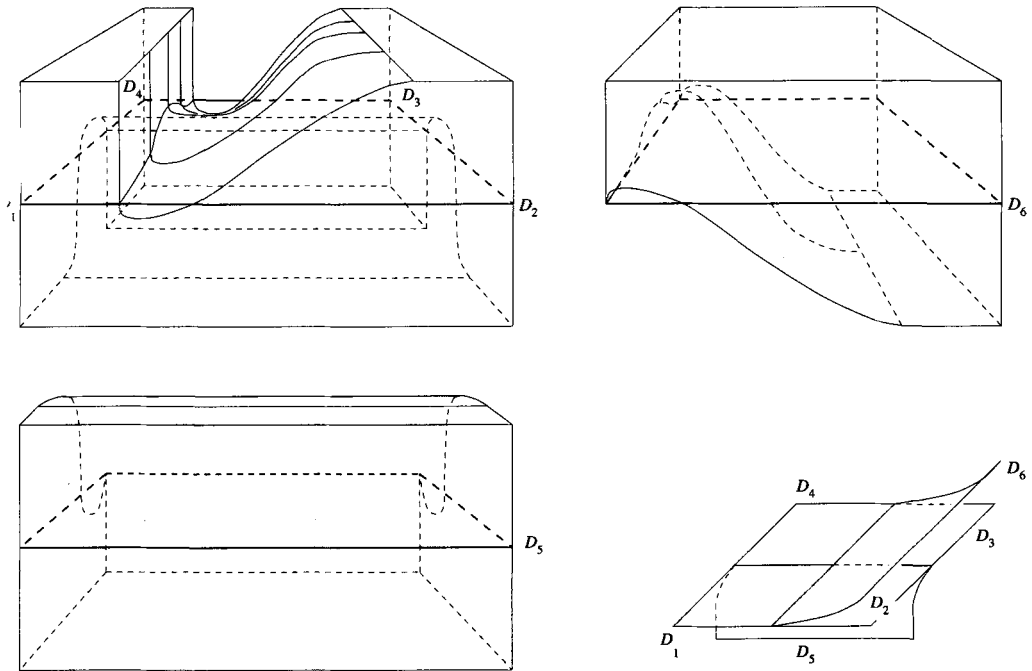

Fig. 11. - Smooth embedding in three dimensions.

LEMMA 5.3. - Let \mathcal{F} be a Morse-Smale foliation on S^2 and ξ_0 on \mathbb{R}^3 be the standard overtwisted structure. Then there exists an embedding $S^2 \hookrightarrow \mathbb{R}^3$ with $\mathcal{F}_{\xi_0}(S^2) = \mathcal{F}$.

This result, together with Proposition 5.2 proves fact 6 from the introduction, and therefore completes the proof of Theorem A. We deal now with facts 7 and 8. We start with a result concerning the manifold M with boundary S^2 , later we will extend the structure to the ball B . Note that in the next statement we use the obvious restriction from \bar{M} to M of the notion of faithful flow-spine.

PROPOSITION 5.4. - Let P be a branched standard spine embedded in M , and let \mathcal{F} be an S -stable foliation on P which has isolated singularities with positive divergence. Then there exists a contact structure ξ on M such that $\mathcal{F}_\xi(P) = \mathcal{F}$ and P is a faithful flow-spine for ξ .

PROOF OF 5.4. - Again we first define ξ on $P \times \mathbb{R}$. With the very same notations as in the proof of Proposition 5.2 we define $\xi = \alpha - t \cdot \eta + dt$. Our choices and compactness of P imply quite easily that such a ξ is indeed a contact structure on some $P \times [-\varepsilon, \varepsilon]$. Now we can rescale the embedding of M in $P \times \mathbb{R}$ so that it takes values in $P \times (-\varepsilon, \varepsilon)$. Thus we have a contact structure ξ on M , and P is a faithful flow-spine because the flow $\partial/\partial t$ in the coordinates $P \times \mathbb{R}$ is positively transversal to both ξ and P , and the boundary of M has only one concave tangency curve.

Now the second step goes exactly as in Proposition 5.2: the property of P being faithful for ξ is preserved under C^∞ small perturbations, whence the conclusion. ■

PROPOSITION 5.5. – *Let P, \mathcal{F}, ξ be as in the previous proposition. Then ξ extends to \widehat{M} within the homotopy class carried by P .*

PROOF OF 5.5. – This fact can be proved in two ways. The most direct one is to use the following result of Eliashberg: if ξ is a plane field on D^3 and ξ is contact near S^2 then there exists a contact structure ξ' on D^3 homotopic to ξ relatively to S^2 . The second approach consists in extending ξ to an arbitrary contact structure and then adjusting the homotopy class of ξ using the methods of Lutz and Martinet on the ball. ■

PROPOSITION 5.6. – *Let P, \mathcal{F}, ξ be as in Proposition 5.4, and assume that ξ is tight. Then ξ extends to a tight structure on \widehat{M} for which P is a faithful flow-spine.*

PROOF OF 5.6. – The idea is to modify the boundary of the ball with the elimination lemma and then fill the ball with the standard tight structure on the unit ball in \mathbb{R}^3 . However one must be careful to preserve existence of a vector field which traverses the ball and is positively transversal to the structure. If in the proof of Proposition 5.4 we start with a small equation α of \mathcal{F} and in \widehat{M} we choose the sphere ∂B very close to P , then we can imagine ∂B as a very flat sphere, e.g. one with equation $x^2 + y^2 + (z/r)^2 = 1$ for some very small $r > 0$, with traversing vector field close to $\partial/\partial z$ and contact structure close to dz . This implies that the elimination lemma is applied only within the upper and lower flat discs into which the sphere splits, and it follows quite easily that the traversing field can be adapted to the new position of the sphere. Now we can safely paste the unit ball in the standard structure with its constant traversing vector field: we only need to take a convex combination of the vector fields in a neighbourhood of the boundary to make sure to get a global smooth vector field with the required properties. ■

This completes the proof of Theorem B.

6. – Concluding remarks.

According to Theorem B, if P is a branched standard spine of \widehat{M} and on P we have an S-stable foliation \mathcal{F} then the abstract pair (P, \mathcal{F}) carries at most one tight contact structure on \widehat{M} up to isomorphism. The problem naturally arises to determine effectively which pairs (P, \mathcal{F}) carry tight structures. The corresponding question for surfaces has been recently answered by Giroux [12], under the (generically true) assumption that the foliation should admit a splitting. Since the definition of splitting makes sense also for branched surfaces (where of course the splitting curve will also be branched), one could speculate that the tightness of a sufficiently generic (P, \mathcal{F}) depends on the topology of its splitting. However the question appears to be rather challenging.

The difficulty in extending the tightness criterion to a branched context could have deep, not only technical, reasons, possibly related to the following discussion. Let us first recall that for a foliated surface (Σ, \mathcal{F}) with splitting curve Γ , Giroux's criterion is actually quite simple: the germ of contact structure carried by (Σ, \mathcal{F}) is tight if and only if either $\Sigma = S^2$ and Γ is connected or $F \setminus \Gamma$ has no disc components. Since a neighbourhood of Σ admits orientation-reversing automorphisms, this criterion is obviously the same for positive and for negative contact structures. Forcing the analogy, assume that also the branched tightness criterion (exists and) is formally the same for positive and for negative structures. Using the results of this paper (in particular, existence) it would follow that a closed oriented 3-manifold \widehat{M} supports a cooriented positive tight structure if and only if it supports a negative one. It was recently established in [14] that there exist closed oriented 3-manifolds which carry symplectically fillable (whence tight) positive contact structures, but do not carry any negative ones (for instance the Poincaré homology sphere). As a consequence we would get examples of tight not symplectically fillable structures.

Another very natural problem is to find necessary and/or sufficient conditions for two pairs (P, \mathcal{F}) and (P', \mathcal{F}') to carry *the same* tight contact structure. In [2] we have provided a calculus based on branched standard spines for homotopy classes of plane fields, so one could hope to refine this calculus to tight contact structures. Again, this does not seem to be straight-forward. A solution of these questions could probably be a significant contribution to the understanding of tight contact structures on general 3-manifolds.

REFERENCES

- [1] B. AEBISCHER ET AL., *Simplectic Topology: an Introduction Based on the Seminar in Bern, 1992*, Progr. in Math. 124, Birkhäuser Verlag, Basel, 1994.
- [2] R. BENEDETTI - C. PETRONIO, *Branched Standard Spines of 3-manifolds*, Lecture Notes in Math. 1653, Springer-Verlag, Berlin, 1997.
- [3] R. BENEDETTI - C. PETRONIO, *A finite graphic calculus for 3-manifolds*, Manuscripta Math., 88 (1995), pp. 291-310.
- [4] J. CHRISTY, *Branched surfaces and attractors I*, Trans. Amer. Math. Soc., 336 (1993), pp. 759-784.
- [5] YA. ELIASHBERG, *Classification of overtwisted contact structures*, Invent. Math., 98 (1989), pp. 623-637.
- [6] YA. ELIASHBERG, *Contact 3-manifolds twenty years since J. Martinet's work*, Ann. Inst. Fourier (Grenoble), 42 (1992), pp. 165-192.
- [7] D. GILLMAN - D. ROLFSEN, *The Zeeman conjecture for standard spines is equivalent to the Poincaré conjecture*, Topology, 22 (1983), pp. 315-323.
- [8] D. GILLMAN - D. ROLFSEN, *Three-manifolds embed in small 3-complexes*, Int. J. Math., 3 (1992), pp. 179-183.
- [9] E. GIORGI, *Characteristic foliations of spheres embedded in the standard overtwisted structure (\mathbb{R}^3, ξ_1)* , To appear in Geom. Dedicata.

- [10] E. GIROUX, *Convexité en topologie de contact*, Comm. Math. Helv., **66** (1991), pp. 637-677.
 - [11] E. GIROUX, *Topologie de contact en dimension 3*, Sémin. Bourbaki, **760** (1992-93), pp. 7-33.
 - [12] E. GIROUX, Seminars given in Pisa in April 1997, paper in preparation.
 - [13] I. ISHII, *Moves for flow-spines and topological invariants of 3-manifolds*, Tokyo J. Math., **15** (1992), pp. 297-312.
 - [14] P. LISCA, *Symplectic fillings and positive scalar curvature*, preprint, Pisa, 1998.
-